

Endurance Series

Commercial Mid-rise Windows Designed to Outlast the Rest

Endurance—the Optimum in Mid-rise Performance

If you are building a mid-rise structure in the Western United States, you are probably specifying the *Endurance Series by VPI Quality Windows*. In a world where demanding specifications and uncompromising job site testing is the way of life, a commercially rated window is the only acceptable solution, as residential windows leave room for unwanted risk. VPI prides itself on superior product performance ratings in the lab and the field. These are the result of our engineering centric organization that is obsessive with safety, quality & customer service, day-in and day-out.

- Commercial profile design coupled with industry leading glazing system delivers the right balance of aesthetics & performance, at a great value
- Our manufacturing process is systematic, documented, controlled and constantly improving
- Structural performance & deflection are enhanced by commercial grade metal reinforcements interconnected throughout the window assembly
- Endless configuration possibilities with fixed, awning and/or casement windows, thanks to an intersecting integral bar system, all assembled within continuous frames – no mulling nightmares!
- Durable, co-extruded acrylic exterior finishes allow for color diversity without compromising structural and thermal performance
- Panel level window design that optimizes water intrusion and air infiltration/ex-filtration

The evolution is complete for mid and high rise commercial and mixed use applications, the future belongs to the Endurance Series window system!

Specify the ideal mix of strength, energy performance and aesthetics with Endurance!

ENDURANCE
SERIES



VPI Quality Windows manufactures ENERGYSTAR® qualified products, that use less energy.

Commercial-Rated Performance:

Engineered for Mid-Rise Construction

PRODUCT	PERFORMANCE							
Casement/Awning	Test Size	AAMA	Infil	Exfil	Water	U-Factor*	SHGC*	VT*
Awning	46" x 32"	CW-PG60	<0.01	<0.01	9.20	0.26	0.18	0.42
Casement	36" x 60"	CW-PG70	<0.01	<0.01	10.66	0.26	0.18	0.42
Fixed	72" x 96"	CW-PG40	<0.01	<0.01	6.04	0.26	0.22	0.51
CPC	96" x 66"	CW-PG70	0.06	0.06	10.66	0.26	0.18	0.42
CPC-AT	108" x 96"	CW-PG40	0.16	0.11	6.04	0.26	0.18	0.42
CP-UT	72" x 78"	LC-PG60	<0.01	<0.01	9.20	0.26	0.18	0.42
Sliding	Test Size	AAMA	Infil	Exfil	Water	U-Factor	SHGC	VT
XO	71" x 56"	LC-PG50	0.08	0.07	7.52	0.28	0.22	0.51
XOX	108" x 66"	LC-PG50	0.05	0.04	7.52	0.28	0.22	0.51
XOXAT	108" x 96"	LC-PG50	0.05	0.04	7.52	0.28	0.22	0.51
SH	56" x 96"	CW-PG30	0.09	0.07	5.43	0.27	0.22	0.51
SH-AU	44" x 108"	LC-PG55	0.04	0.03	8.36	0.27	0.22	0.51
SH-PW-SH	108" x 96"	CW-PG30	0.06	0.05	6.90	0.27	0.22	0.51

* Assumes Cardinal LoE 366

Some select configurations. Bring us your designs.

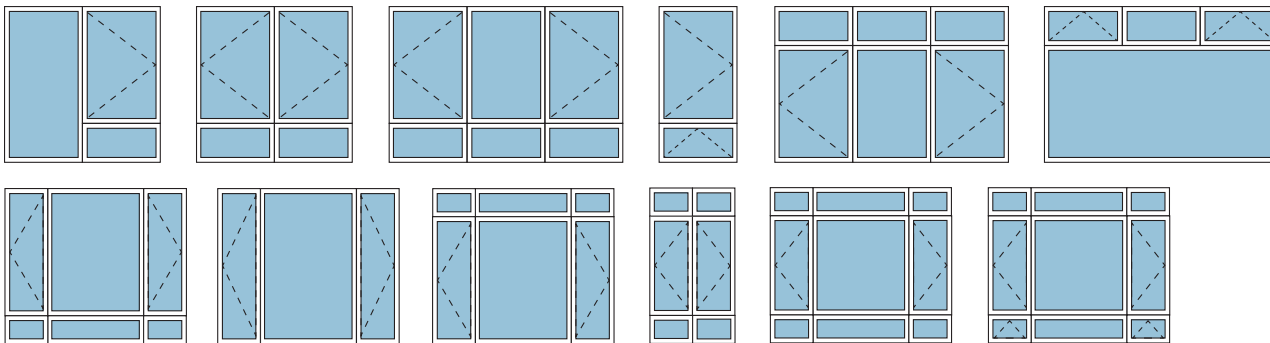

PRODUCT							
Window Type	Glass Configuration	Spacer Size	Argon	Lami	STC	OITC	
AWN/CAS	1" - (1/4" - 0.030" - 1/2" AS - 1/4")	0.500	Yes	0.030	36	30	
PW	1-3/8" - (1/4" - 0.030" - 13/16" AS - 9/32" - 0.060")	0.813	Yes	0.030/0.060	38	29	
AWN-U	1-3/8" - (1/4" - 0.030" - 7/8" AS - 1/4" - 0.030")	0.875	Yes	0.030	41	33	
XO	1" - (3/16" - 9/16" AS - 1/4" - 0.030")	0.563	Yes	0.030	36	29	
SH	1" - (1/4" - 0.030" - 9/16" AS - 3/16")	0.563	Yes	0.030	35	29	

Standard Configuration Features:

- **COMPRESSION-SEAL DESIGN** enhances protection against water intrusion, air infiltration, and allows ease of glass replacement
- **VINYL FRAMES** Increase thermal performance, add color options, and reduce condensation
- **FRAME AND SASH** have hollow compartments that allow for optimal reinforcement required in heavy commercial applications
- **FUSION WELDED CORNERS** provide environmental comfort and protect against leaks
- **AVAILABLE MULTIPLE LOCKING POINTS** ensure security and provide a triple weather seal for superior air and water resistance
- **EASY TO OPERATE HARDWARE** delivers a wide opening for emergency egress and cleaning
- **T-BAR** allows for freedom of design while maintaining structural and thermal performance

Selected CAD Details

CAD files in DWG and PDF format and specifications for most products can be downloaded from www.VPIwindows.com/cad

Casement Awning 3 1/2" Frame Depth

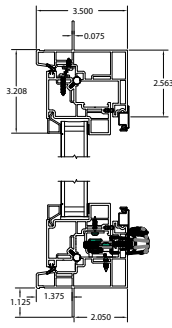
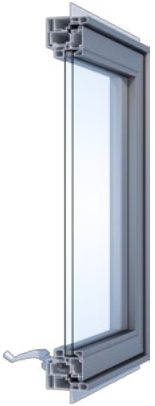

Casement Horizontal

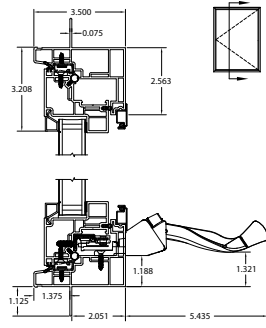

Casement Vertical

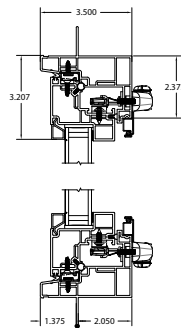

Awning Horizontal

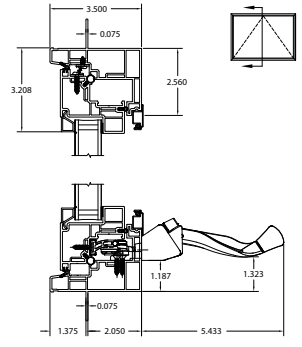

Awning Vertical

Fixed Window 3 1/2" Frame Depth

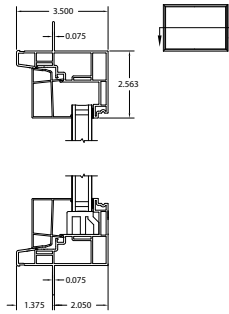

Picture Window Vertical
Available with IGUs 3/4"-1-1/4"OA

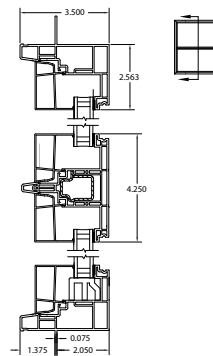

Picture Window Vertical
with Narrow T-bar

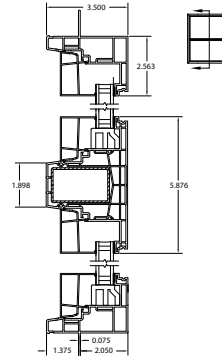

Picture Window Vertical
with Wide T-bar

Single Hung 3 1/2" Frame Depth

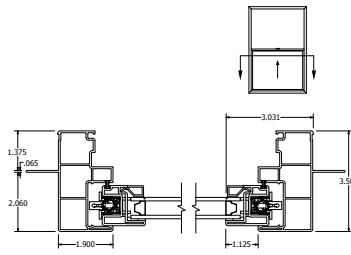

Single Hung Upper Horizontal Section

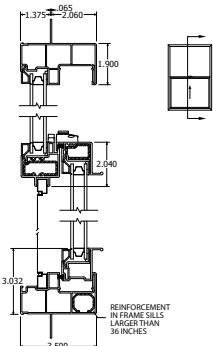

Single Hung Operable Vertical Section

Horizontal Slider 3 1/2" Frame Depth

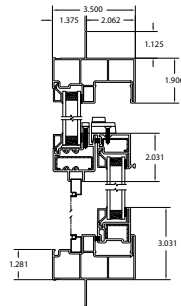
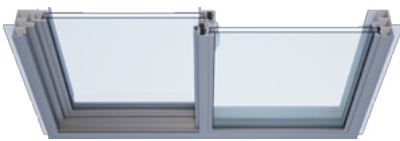

Horizontal Slider

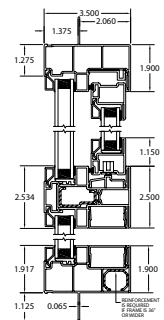

Horizontal Slider
Above Fixed

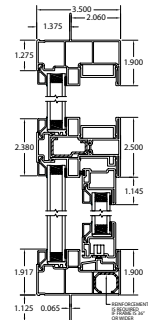

Horizontal Slider
Below to Fixed

Performance that Exceeds Expectations



Just Ask Our Customers

"VPI performance is better and more consistent than any of the vinyl window products we've used."

Lake Washington Windows.

"Thornton Place was the largest project to date for Walsh Seattle and was full of challenges. Your dedication and collaboration were instrumental... On behalf of a grateful Company, we thank you."

Walsh Construction.

"We are very satisfied with VPI. VPI window products demonstrate a blend of solid performance, high quality manufacturing and color options that are unique in the industry."

The Soltner Group, Architects Inc.

The Proof is in Our Performance

Backed by one of the strongest warranties in the business, including ten year seal failure coverage on most glass units, project owners can be confident that the Endurance Series™ will stand the test of time.



ENDURANCE
SERIES

vpi Quality Windows

www.vpiwindows.com
(800) 634-1478 | info@vpiwindows.com
3420 E. Ferry, Spokane, WA 99202